

Operating and installation instructions



Dosing system Oxy-Dos 10-V1

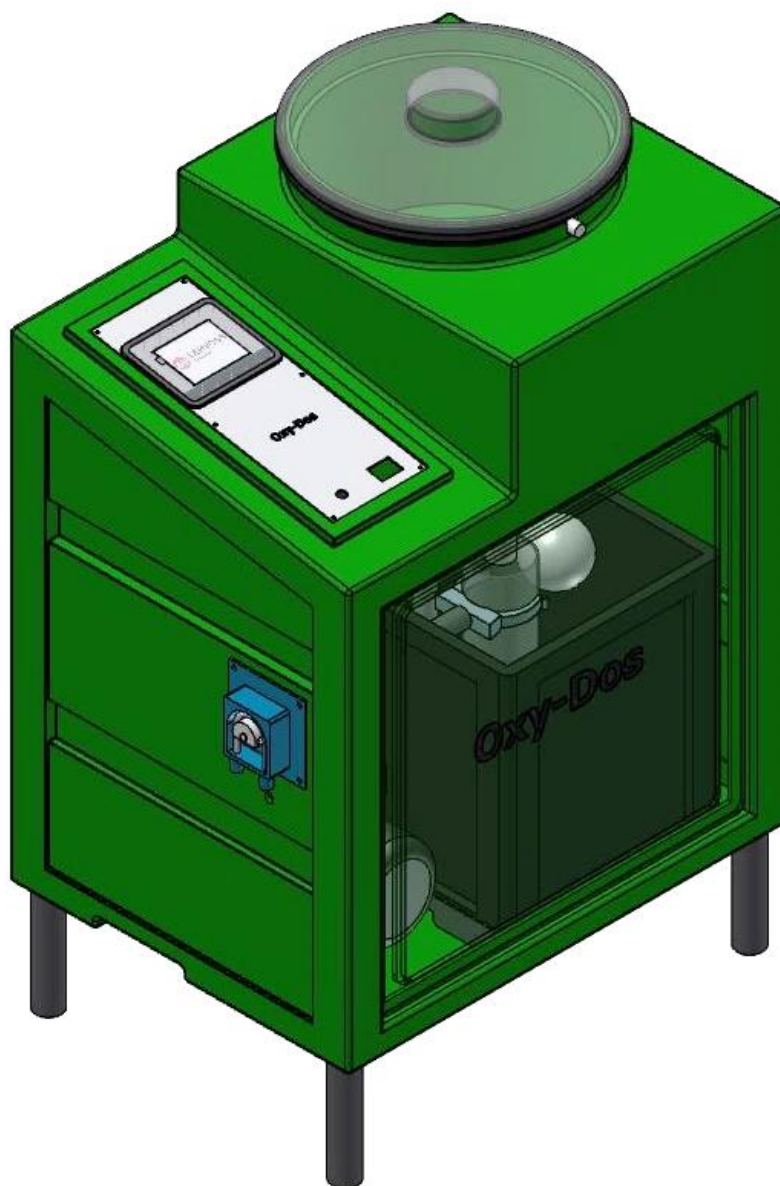

Table of contents

1	Information regarding these instructions / general information	4
1.1	Scope of validity	4
1.2	Target group	4
1.3	Symbols used.....	4
1.4	Warranty	5
1.5	Further information.....	5
2	Safety	6
2.1	Appropriate use	6
2.2	Safety instructions:	6
2.2.1	.Handling of chemicals, risks to persons and the environment.....	6
2.2.2	.Protective measures and behavioural rules.....	6
3	Product description	8
3.1	Transport / storage.....	8
3.2	Functional description of the Oxy-Dos 10-V1.....	8
3.3	Technical data / name plate.....	9
3.4	Housing.....	10
3.5	Dosing system for oxygen granule dosing	10
3.6	Rinsing system	11
3.7	Algaecide dosing.....	12
3.8	Temperature measuring (option)	12
3.9	Control NT35-01	12
3.9.1	.The operating elements	12
3.9.2	.Dosing diagram	13
4	Assembly	14
4.1	Scope of delivery – Erection.....	14
4.2	Connection to the filter piping.....	14
4.3	Assembly of the temperature sensor (option)	15
4.4	Algaecide pump - Assemble roller carrier.....	15
4.5	Electrical installation	15
5	Initial operation	17
5.1	Commissioning - comments.....	17
5.2	Checking of the rinsing water pump	17
5.3	De-aeration of the rinsing water pump – Adjust as to the pressure values	17
5.4	Adjustment of the water level in the rinsing tray	18
5.5	Prepare algaecide dosing for operation – for assembly!	18
5.6	Filling the filling hopper with oxygen granule.....	18
6	Operation / handling.....	19
6.1	The main menu	19
6.1.1	.Login main menu	20
6.2	Operating modes menu.....	20
6.2.1	.Operating mode clock timer, settings at 24 h cycling time.....	21
6.2.2	.Operation mode continuous, adjustments in case of a limited filter run time	22
6.2.3	.Operating mode External control	24
6.3	Settings menu.....	26
6.3.1	.Menu Adjust dosing power for oxygen and algaecide	26
6.3.2	.System menu	27
6.4	Service menu.....	30
6.4.1	.Inputs test menu	30
6.4.2	.Outputs test menu.....	31
6.4.3	.Test dosing menu quick walk through	31
6.4.4	.Test menu for manual dosing.....	31
6.4.5	.Information test menu	31
6.5	Logout.....	32
6.6	Top up consumables.....	32
7	Maintenance, service	33
7.1	Device maintenance.....	33
7.2	Exchanging the dosing unit	33
7.3	Change the floater regulating valve for the supply to the rinsing tray	33
7.4	Change the dosing hose of the algaecide pump	33

7.5	Errors with error message in the display	34
7.6	Errors that are not being shown.....	35
8	Shutting down - Storage - Disposal.....	36
8.1	General	36
8.2	Shutting down	36
9	Documents.....	37
9.1	Declaration of conformity	37
9.2	Terminal plans - power board / net board	38
9.3	Commissioning report.....	39
9.4	Maintenance protocol.....	40
9.5	Spare parts list, wearing parts list	41
10	Appendices.....	42

Imprint

All rights reserved

© Copyright by WDT – Werner Dosiertechnik GmbH & Co KG

Version: see footer

Publications of any kind and translation into other languages, also of excerpts, is only permitted with the explicit approval of WDT - Werner Dosiertechnik GmbH & Co. KG.

These operating instructions are based on the German original provided by the WDT company.

Responsible for the content:

WDT - Werner Dosiertechnik GmbH & Co. KG

Hettlinger Str. 17

D-86637 Wertingen-Geratshofen

Phone:+49 (0) 82 72 / 9 86 97 – 0

Fax:+49 (0) 82 72 / 9 86 97 – 19

E-mail: info@werner-dosiertechnik.de

1 Information regarding these instructions / general information

1.1 Scope of validity

These instructions describe the function, installation, commissioning and operation of the Oxy-Dos 10-V1 dosing system with appropriate accessories.

The operating instructions must be carefully read before using or maintaining the device and have to be stored in immediate proximity of the device!

1.2 Target group

Only our authorised partners and persons who were instructed regarding the device functions and have read and understood the operating instructions may work on the system.

Electrotechnical connection work may only be performed by appropriately trained specialist staff!

1.3 Symbols used

The following types of safety instructions and general instructions are used in this document:



DANGER !

"**DANGER**" indicates a safety instruction that must be adhered to at the risk of death or severe injury!



CAUTION !

"**CAUTION**" indicates a safety instruction that must be adhered to at the risk of light to medium injuries!



ESD-SENSITIVE !

"ESD SENSITIVE" identifies electronic components that can be damaged by electrostatic discharge. The generally known precautions regarding ESD-sensitive devices must be adhered to when handling these devices!



ATTENTION !

"**ATTENTION**" indicates a safety instruction that must be adhered to at the risk of damage to goods breakdowns!



Hint !

A "**Hint**" characterises information that may help to improve the operation.



Mandatory sign

Use face protection!



Mandatory sign

Use protective gloves! According DIN EN 374



Mandatory sign

Use protective apron!

1.4 Warranty

All devices and systems of the WDT company are produced using the latest production methods and comprehensive quality control. Please send your warranty claims according to the general warranty conditions (see below) to WDT should there nevertheless be a reason for complaint.

General warranty conditions

WDT provides a warranty for 2 years from the date of commissioning, a maximum period of 27 months after delivery, assuming correct installation and commissioning with completed and signed commissioning protocol.

Wearing parts such as seals, hoses, membranes, dosing screw conveyors, electrodes, roller carriers and other parts that are subject to mechanical or chemical wear are excluded. We provide a warranty for half a year on those parts.

Our ERP program requires an invoice for each delivery (also for warranty services). Customers will receive a credit note after returning the faulty part and its inspection as required. Please return goods within 14 days.

Costs for consequential damage and costs resulting from handling warranty claims are excluded.

Warranty claims are not valid when the damage was caused by frost, water, over-voltage or inappropriate handling.



Tipp

Hint !

Please send a completed commissioning protocol together with the defective part to WDT to maintain your warranty claims. We reserve the right to settle the warranty claim when no completed commissioning protocol is available.



Achtung!

ATTENTION !

Modification of the device is not permitted. Warranty and product liability claims become void when this requirement is not fulfilled.

1.5 Further information

Additional information regarding specific topics such as description of the operating parameters as well as further support is available from your specialist dealer.

2 Safety

2.1 Appropriate use

The dosing system Oxy-Dos 10-V1 is only built to be used in the water treatment for the private pool.

2.2 Safety instructions:

The operating instructions must be carefully read and considered before installation and use! The locally valid regulations (e.g. Accident Prevention Regulations, DGUV) regarding accident prevention, worker safety and drinking water protection must be adhered to during installation!

Work on the system and changes to the settings may only be performed by trained and instructed specialist staff!

Take note of the warning information on the device!



Caution!

Modification of the device is not permitted!

2.2.1 Handling of chemicals, risks to persons and the environment

In emergencies relating to the handling of chemicals, you can contact a Poison Emergency Call Centre!

Emergency call number:

Poison Emergency Call Munich (or any other poison centre)

Telephone: +49 89 19240

2.2.2 Protective measures and behavioural rules



PROTECTIVE EQUIPMENT !

The oxygen granulate and the algacide may not be mixed with each other or with other chemicals and substances!



We recommend to use face protection and protective gloves



Store the chemicals to ensure that unauthorised persons cannot access them. For the storage of chemicals, see the instructions in **Section 3.1, Storage of chemicals and the instructions on the supplied containers.**

Other important things to be respected:

1. The dosing hopper and the supply tank must be closed with the cap immediately after filling.
2. Clean spoiled chemicals immediately with water.
3. Only instructed staff may perform works at the dosing system.

More information is provided in the safety data sheets of the chemical substance producers!



ESD-SENSITIVE !

The electrical components in the control units of the systems are sensitive towards electrostatic discharge. The generally known precautions regarding ESD-sensitive devices must be adhered to when handling these devices!

Disconnect the system from the power supply

Discharge the personal static charge

3 Product description

3.1 Transport / storage

The device must be checked for possible transport damage immediately after receipt.



ATTENTION !

The systems and devices can be damaged by frost or high temperatures. Prevent exposure to frost during transport and storage!

Do not store the device next to objects with high heat radiation or directly exposed to sunlight. The device may only be transported and stored in its original packaging. Careful handling must be ensured.

3.2 Functional description of the Oxy-Dos 10-V1

The dosing system Oxy-Dos dient of the disinfection pool water with the use of oxygen granulate and optionally with algaecide.

Functional principle of the Oxy-Dos dosing system

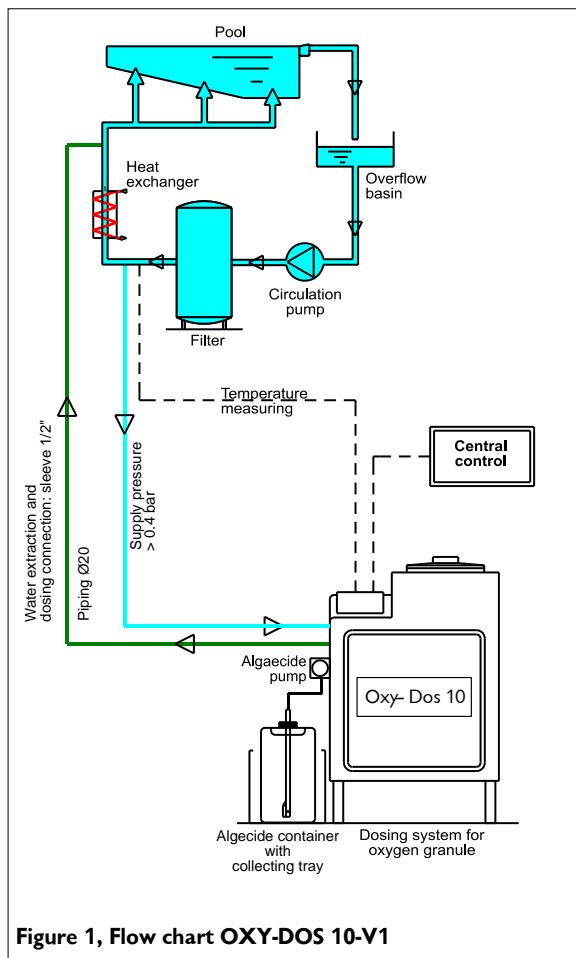

Figure 1, Flow chart OXY-DOS 10-V1

With the Oxy-Dos a dosing system is available with which oxygen granulate is dosed directly into the pool water circuit. Therefore the granulate is dosed with the dosing unit into the rinsing system, from which it is supplied with a circulation pump into the pipeline of the pool water circuit. The chemicals are dissolved completely. The water supply to the rinsing device is regulated through a floater valve. Level switches in the rinsing tray monitor the regulated water flow through the system. The programming of the dosing is done by means of a touch display with dosing volumes that can be adjusted every day.

To avoid possible algae building an optional dosing pump for algaecide is installed. The dosing device Oxy-Dos is specially foreseen for private pools with a volume of 30-200 m³.

3.3 Technical data / name plate

The dosing system “Oxy-Dos 10” consists of following components:

- Housing of sintered PE, green
- Dosing hopper 15kg with dosing unit for oxygen granules
- Rinsing system for oxygen granules
- Dosing system for algaeicide
- Control NT35-V1

Dimensions:

Base area W x D 65x55 cm
Height: 95 cm
Weight: approx. 30 kg

Material:

Housing PE rotational sintered, green
Dosing hopper: PE
Rinsing system: PP

Max. dosing performances*

Oxygen: 5 kg/h
Algaeicide: 3 l/h

Operating water pump:

Rotary pump Lo-V4A, 230 VAC, 0.4 kW,
Pre-pressure: minimal 0.4 bar
Back pressure: 0 – 1.5 bar, depends on the pre-pressure
Water throughput: approx. 800 - 1000 l/h

Control:

Processor control with touch display
Function and error messages alpha numerical with touch display

The name plate:

Put here the data from the name plate. Serial no. and manufacturing date

<p>Typ: Oxy-Dos 10-V1 Art.: 20540 Serien Nr.: <input type="text"/> 230V/AC 1Ph~ 50Hz I_{max.} 3,15 A Dosierleistung 5,0 kg/h-1,0l/h Herstellung <input type="text"/></p> <p>CE WDT - Werner Dosiertchnik GmbH & Co. KG Hettlinger Straße 17 D - 86637 Wertingen</p> <p>Figure 2, Name plate</p>

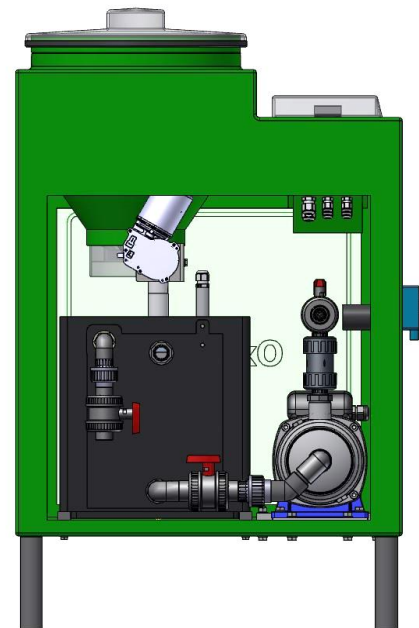

In case of questions about the device, please indicate always article number and serial n° to prevent misunderstandings.

3.4 Housing

The housing is sintered from a piece of green PE and therefore extremely rugged. The dosing device is put into the housing from above, and can be easily extracted, for example for maintenance works. In a deepening at the left in the upper part of the housing, the control is installed. Dosing hopper and control are protected against splash water by means of a transparent lid. In the lower part of the housing there is the rinsing installation for the granulate; the algacide pump is installed at the left side on the housing.

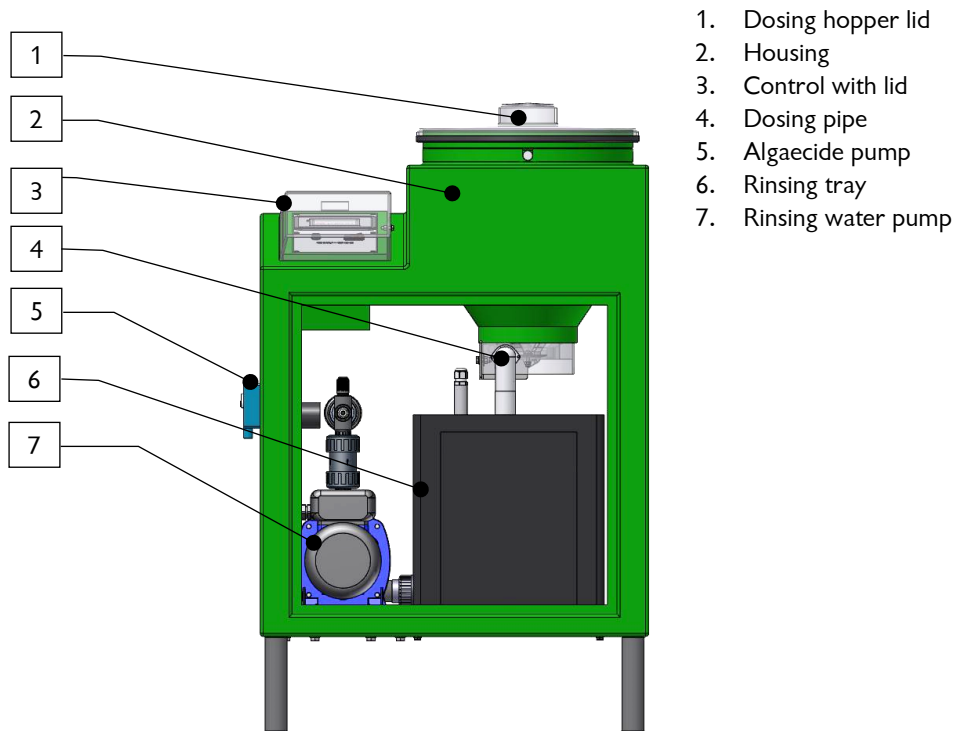

3.5 Dosing system for oxygen granule dosing

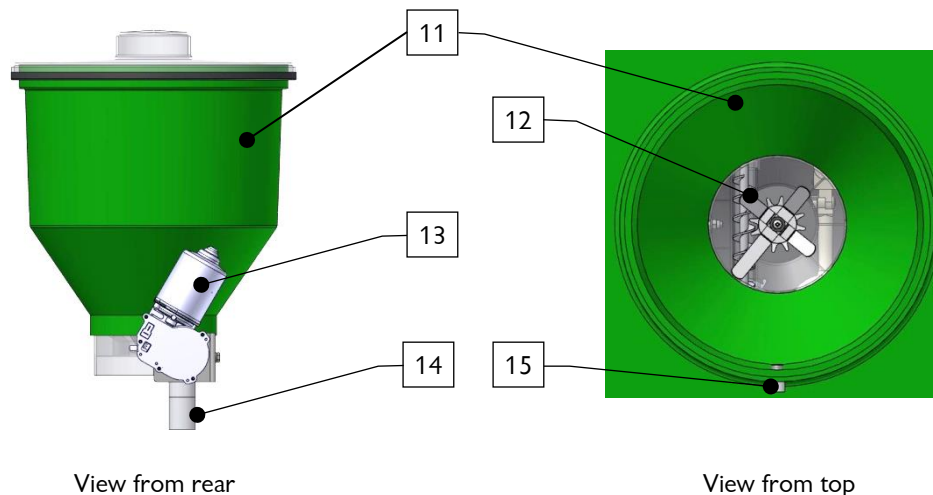

The dosing system consists of:

11. Dosing hopper with transparent lid
12. Dosing unit with dosing motor, dosing screw and moving wing for the granule
13. Dosing motor
14. Downpipe
15. Centering bolt

The dosing system consists of a dosing hopper (11) with a capacity of approx. 15kg and a dosing unit that includes the dosing motor (13) with the dosing screw and the moving wing to support the dosing. The dosing unit is screwed at the lower part on the dosing hopper.

The dosing hopper is closed tightly with the lid.

For maintenance works at the dosing device, this is completely extracted from the housing from above.

The desired dosing power is adjusted by means of day and volume adjustments on the touch control.

3.6 Rinsing system

The rinsing system consists of:

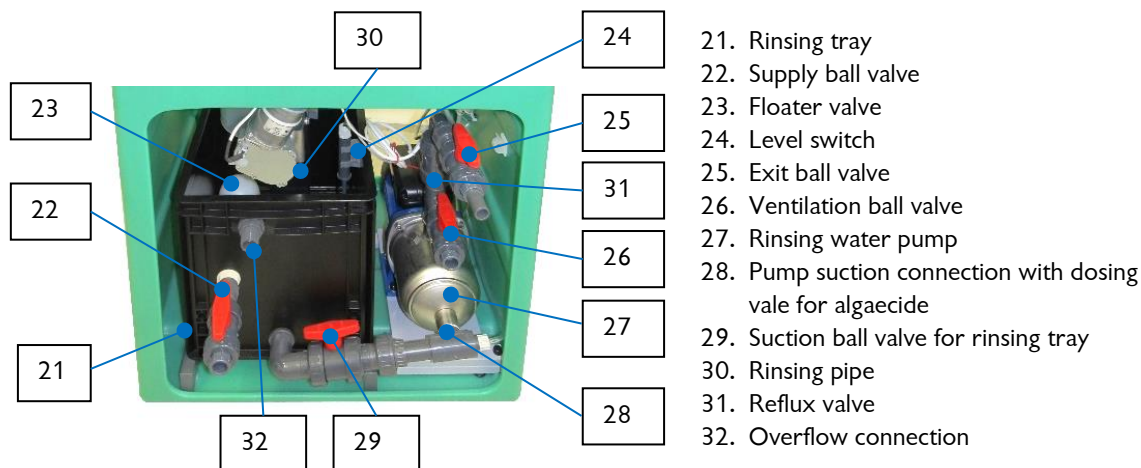

The oxygen granulate falls from the pipe of the dosing device into the rinsing pipe (30), where it is sucked from the bottom through the piping (28, 29) from the conveying pump (27) and is taken to the clean water conduct of the pool circuit. The oxygen granulate is completely dissolved.

The rinsing water (the water is taken behind the filter) coming from the filter circuit is taken through the supply valve (22) and the floater valve (23) to the rinsing tray. The floater valve regulates the water supply in such a way that the water level in the rinsing tray, according to the suction by means of the rinsing water pump, remains constant. Changes in the water supply of the rinsing device that could cause the bad working of the rinsing device, are registered by means of the level switches Min/Max (24); the dosing of chemicals and the rinsing water pump are in these cases disconnected to avoid possible additional damages.

To avoid a return movement of water from the pool upon disconnection of the rinsing pump a reflux valve (31) is placed on the valve, the floater valve in the supply line closes at the end of the dosing program the water supply tightly.

If one of the two safety systems does not work correctly, the resulting small water overflow is taken by means of the overflow connection (32) to the gully. The level switch (24) indicates this fact, and in that case maintenance works are to be carried out.

3.7 Algaecide dosing

The dosing pump for the algaecide is installed at the left-hand side on the housing.

The hose pump sucks the algaecide through the suction lance from the algaecide can and conveys it to the inoculation place on the suction connection (28) of the rising water pump. A level switch registers the empty state in the can, the empty message is shown in the display.



The dosing of the algaecide is programmed, as in the case of the oxygen dosing, through the touch control in the sequence of the dosing program. Here it is also possible to define whether algaecide must be dosed or not.

3.8 Temperature measuring (option)

The oxygen consumption of a pool depends also on the water temperature. In the water return conduct towards the pool the optionally available temperature sensor PT1000 can be installed (see Section 4, Assembly). This can be clamped onto the control of the Oxy-Dos. In case of an increase of the water temperature, the dosing power for the oxygen granulate is increased automatically.

3.9 Control NT35-01

3.9.1 The operating elements

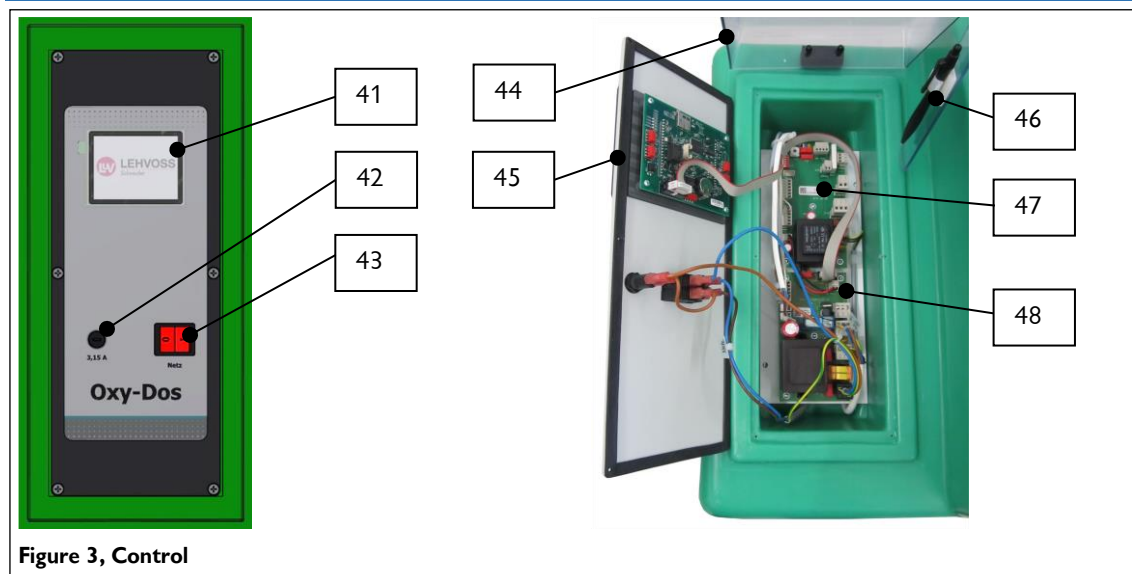

Figure 3, Control

The micro-processor-supported controller of the Oxy-Dos 10-V1 can be simply and consistently operated by using the touch display.

The control of the Oxy-Dos is installed in the dust and splash water protected housing. External switches and error messages are clamped on the control places situated in the lower part of the housing tray (47, 48) (see *terminal scheme, Section 9.2*). The touch-control is connected with the front plate to one unit.

Operating elements at the outside on the front plate:

41. Touch display
42. Main fuse
43. Main switch
44. Lid for the control
45. Front plate with touch display
46. Support and operating pen
47. Control plate NT35
48. Control plate NT35 V1, expansion

3.9.2 Dosing diagram

Notice about the KIPS-consumption: appr. 15-30 g/m³ pool contents/week
The oxygen consumption in the water must be 10-30 mg/l.

The dosing of the oxygen granulate is always done intermittently in a defined dosing cycle:

Dosing cycle - Sequence after the start.

- Rinsing pump on 10 minutes. When there is no error, then
- Dosing of the granulate volume as adjusted and/or as corrected by means of the temperature factor. Dosing volume in steps of 10 g of 10-1000 g then
- Refill 10 minutes, then
- End dosing of the algacide, if this step is activated – dosing volume adjusted in ml on the touch -
- Refill appr. 10 minutes to clean the rinsing device

3 operation modes are available:

1. The filter system is working 24 hours.

Dosing start according to week calendar, selection of the days, adjustment of a starting time, for example start at 8.00 h.

2. The filter system is only working during limited periods of time, sometimes also several times a day

Adjustment of a time window for the dosing, for example 8.00-10.00.

Dosing start 30 minutes after the connection of the filter system in this time

3. Dosing start through an external control device, for example oxygen measurement

Adjustment of a time window for the dosing, for example 8.00-10.00.

Dosing start 30 minutes after the start of this time

Normally dosing is only done 1x a day.

For the adjustment of the operation modes and the dosing powers in the menu, see Section 6.2 Menu operation modes.

The adjusted dosing powers can be changed at any time, for example when the oxygen measurement is too low the next day.





4 Assembly

4.1 Scope of delivery – Erection

The work described here should only be performed by appropriately trained and instructed persons who have fully read the operating instructions and are familiar with the device.

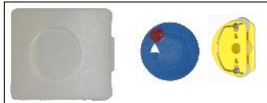
Unpack the Oxy-Dos device and erect it in the technical room, and align. Ensure that there is sufficient free space for operating and maintaining the device!

In the dosing hopper you will find the illustrated bag with the following parts:

<p>Spare parts bag with joints and diaphragm</p> 	<p>Accessories for algaecide pump</p> 
<p>4 feet with screw thread M6</p> 	<p>Dosing valve for algaecide</p> 
<p>2 ball valves d20 with adhesive nipple d20 and transition nipple d20-1/2</p> 	

Important:

Keep the bag with the spare parts at the device so that the parts are always available!

Procedure:

1. Tip the device forward and screw the rear feet, then tip backwards and screw the front feet
2. complete the supply ball valve at the rear side on the rising container
3. Install the hose conduct from the overflow to the gully.
4. If the Oxy-Dos is put in a drip tray, the overflow of the Oxy-Dos leaves the tray. If necessary, also longer feet can be used.

4.2 Connection to the filter piping

The rinsing water is taken from the return conduct of the water to the pool and is returned with the dosed chemicals approximately 0.5 meter behind the extraction point or, when a heat exchanger is installed, behind this heat exchanger. We recommend to put 2 perforation clips onto the piping with 1/2" connection: 1x water extraction, 1x for the water return. Option 1x connection for the temperature sensor. Always screw a ball valve 1/2" in the water connections.

In case of connection of the Oxy-Dos in the water circulation, pay attention to the pressure values!

The flow pressure in the clean water conduct must be at least 0.4 bar. See also "Commissioning". The pre-pressure in the clean water conduct must be at least 0.4 bar, the rinsing water must be taken between the filter pump and the filter. **In this case an additional protection filter must be installed.**

Ensure that any connections already installed are not blocked. The connecting pipes must be kept as short as possible. We recommend to realise the connection between the device and the filter piping with a hose 3/4"-di20 so that movements of the device do not cause a stress on one of the realised fixed pipes.

4.3 Assembly of the temperature sensor (option)

Install the temperature sensor next to the water extraction in the piping and connect to the control.

4.4 Algaecide pump - Assemble roller carrier

Extract the dosing hose to the front side from the housing, put the roller carrier onto the shaft. Turn the roller carrier to the right-hand side and slide the pump hose through the recess on the roller carrier backwards into the housing, turn a few times. Slide the lock washer onto the shaft and the housing lid. Place the suction device in the algaecide can.

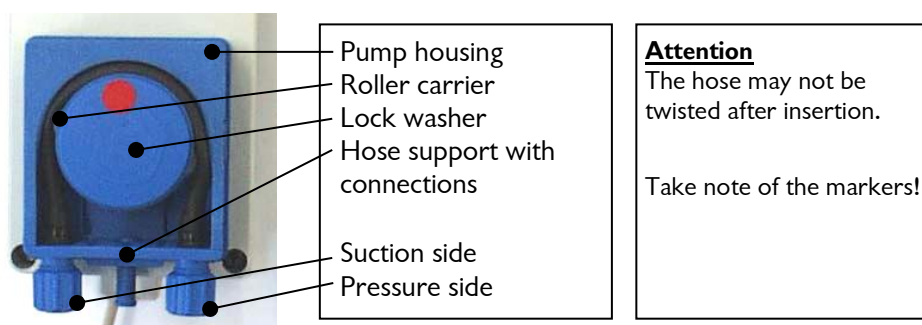

4.5 Electrical installation



DANGER DUE TO HIGH VOLTAGE !

The electrical installation may only be performed by appropriately trained specialist staff! The power supply must be switched off and secured against switching on before performing any electrical work!

The electrical supply of the Oxy-Dos must be locked with the filter system so that the Oxy-Dos can only work when the filter system is working.

The Oxy-Dos is supplied ready for operation with a 3 m long cable with shockproof plug.

The control of the Oxy-Dos provides a **potential free** exit for a collective fault signal that can be laid on an existing filter control, with the aid of a flexible cable (for example 2 x 0.5).

The lid (44) of the control can be turned upwards for installation and service works and can be supported downwards with the support clamp (46) at the right-hand side. In this way the operation of the touch display can be done easily with the operation pen and the control parts in the lower side of the control housing can be reached as well.

For the connection external cables, loosen the 6 screws of the front plate and put the front plate with the touch display aside. Introduce the cable from behind through a free cable screw connection and according to the terminal scheme.

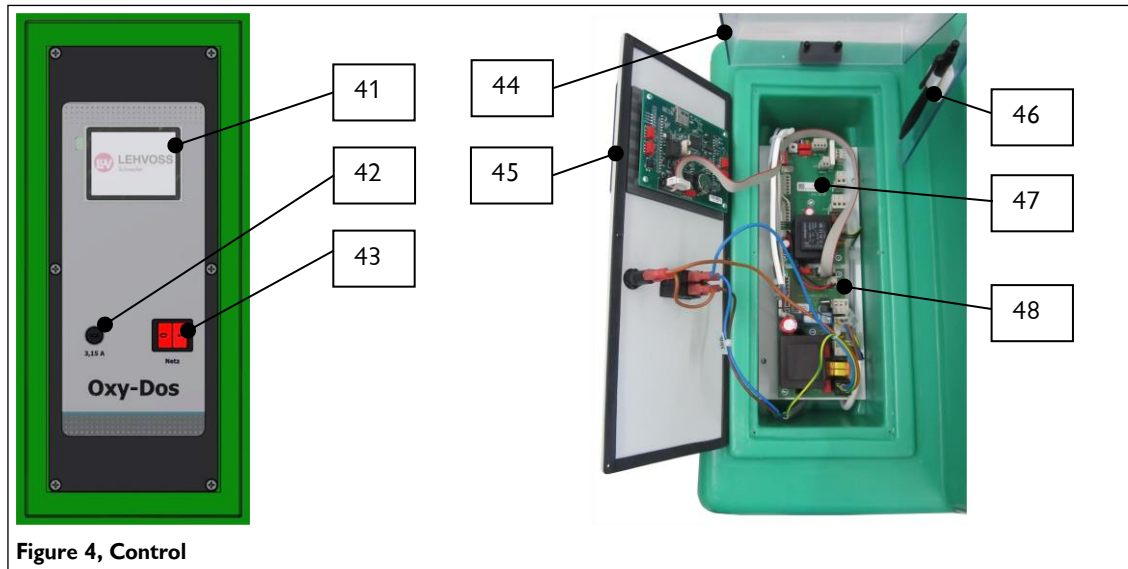

Figure 4, Control



ATTENTION !

The electronic components of the devices are sensitive to electrostatic discharge.

The following needs to be considered:

- Only pull or push in the plug-in connectors when they are not under tension.
- Discharge yourself, as operator, electrostatically during at least 5 seconds before touching the devices directly, for example by touching an earthed part of the system, for example the metallic pump head.

5 Initial operation

5.1 Commissioning - comments



ATTENTION !

This chapter must be considered when operations are resumed after an operating break. Complete the commissioning report. Only switch on the Oxy-Dos 10-V1 when the rinsing tray has been filled.

Before the commissioning, the installed systems must be checked as to correct installation and tightness. For the commissioning, please use the commissioning report from *Section 9.3. Initial operation works.*

The work described here may only be performed by appropriately trained and instructed persons who have fully read and understood the operating instructions and are familiar with the device. **Especially the chapter “Main menu” must be followed.**

5.2 Checking of the rinsing water pump

First check the smooth working of the pump, and de-aerate the pump and the piping:

It must be manually checked whether the rotary pump can easily be turned. Therefore check the shaft as to smooth working on the fan wheel of the pump engine. The floating ring seal is clogged when the shaft **cannot** be easily turned. Try to loosen it by jerking it backwards and forwards. The pump must be removed and disassembled in case this is not possible.



ATTENTION !

Failure of the pump is inevitable when the pump is switched on while the floating ring seal is blocked.

5.3 De-aeration of the rinsing water pump – Adjust as to the pressure values

Open the ball valves at the water extraction and dosing place, as well as on the supply at the rinsing tray and the ball valve to the suction connection of the pump. The water enters into the rinsing tray. At the outlet nipple of the de-aeration ball valve (26) put the supplied hose piece d20 and put the end in an empty water bucket.

When the rinsing tray is full of water, proceed to the log-in in the touch display of the control.



Select the login button in the main menu to introduce the password (standard adjustment “0123”).



Select program “Service functions”



Select test menu “Hand dosing”

A complete dosing procedure is carried out.

Now the pump is sucking water from the rinsing tray and sends it without pressure to the bucket. After approximately 10 litres the pump must be completely de-aerated. Close the *de-aeration ball valve (Pos 26, page 18)* again, now the container is being filled again. At the end of the dosing cycle, the rinsing pump is disconnected again.

After opening the *exit ball valve (Pos 25)* the pump sucks water from the rinsing tray, the water level falls, the floater valve lets water flowing. The water level must be stable, approximately in the middle between the upper and the lower switching point of the level switch.

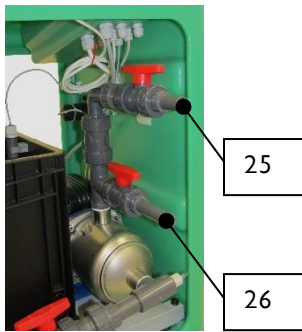

However, depending on the pressure values, the water level in the rinsing tray can continue increasing or decreasing. To compensate the existing pressure values, perforated sheets are used in the screw connection behind the angle with different perforation diameters.

In the plant a perforated sheet with a perforation of 5 mm is applied, for pressure values of **0.5 to 1.2** bar. In case of a lower pressure of **0.4 to 0.5** bar the sheet with a perforation of 4 mm must be used, being included in the by-pack. In case of a lower pressure (flow pressure under 0.4 bar) see Section 4.2.

5.4 Adjustment of the water level in the rinsing tray

The water level must be stable between the upper and the lower switching point of the level switch. The water level in the rinsing tray is changed by adjusting the floater at the floater control valve. After loosening the wing screw the floater location can be changed: upwards, when the water level is too low or downwards, when the water level is too high.

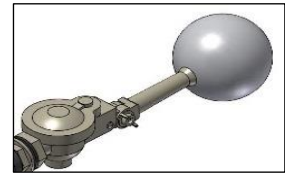

5.5 Prepare algaecide dosing for operation – for assembly!



The specifications in the safety data sheets for the respective chemicals must be adhered to, e.g. protective clothing:

Connecting the algaecide container

1. Place the full canister into the protective container.
2. Unscrew the screw lid from the full can, place the suction device of the dosing system Oxy-Dos 10 in the can and tighten the screw lid loosely.
3. Store the original screw lid of the can till the next replacement of the container - the empty can must be tightened again.

5.6 Filling the filling hopper with oxygen granule



PROTECTIVE CLOTHING !

The safety data sheets for the respective chemicals must be adhered to.



ATTENTION !

Oxygen granule and algaecide may not be mixed with each other or with other chemicals and substances! Fill only the necessary oxygen for approximately 2-3 weeks.

- Carefully pour the oxygen granule along the wall into the filling hopper using a cup, so that no dust is generated (do not tip!).
- Do not fill more than the required volume for approximately 2-3 weeks, so that the oxygen granulate does not bind with the air humidity, does not agglutinate and does not flow worse. Then the filling hopper and the supply container must be closed with the lids.



NOTICE !

Now the device is ready for use.

6 Operation / handling



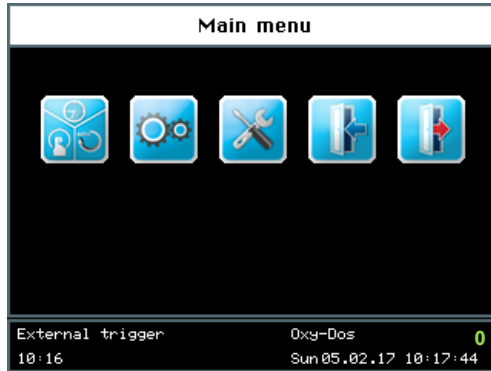

6.1 The main menu

The main menu is displayed after switching on the device at the main switch.
5 main groups may be selected from the main menu

The main menu



Explanation of the symbols

-  1. Operating modes Section 6.2
-  2. Settings
Dosing performance, system settings Section 6.3
-  3. Service menu
Test functions
-  4. Password entry (factory setting 0123)
-  5. Logout
Successful logging off is indicated by a green "0" in the information bar!

The information bar:



The information bar remains visible at the bottom of the screen. It shows the following information:

- a) Display of the operating mode; e.g. System Reset
- b) Device description; Oxy-Dos
- c) Level of user rights in green font; 0-1
- d) 00:00:00; time information
- e) Day of week, date, time

The navigation field



After tapping the input field, the font turns white and the navigation field is automatically shown. The desired values are set with the arrow buttons and confirmed with **OK**.

With the double arrows the values are adjusted in "steps of 5".

With the simple arrows the values are adjusted in "steps of 1".

The values are saved with the **SAVE** button while **ESC** terminates the input process.

6.1.1 Login main menu

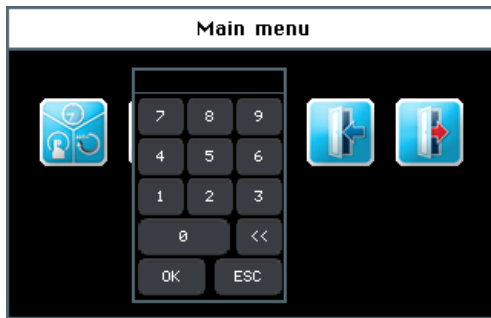

Login is required before settings can be entered into the device.



For login, touch the login button in the main menu, to introduce the password (**standard adjustment "0123"**).

For the adjustment of the control there are 2 different user levels.

User level 0	Guest	Reading rights
User level 1	Final customer	Carry out adjustments

The respective user level 1 is shown in green on the information bar of the display after successful login. The

desired changes to the controller can be performed thereafter. Use the Logout button  to log out after completing the settings. Also see Section 6.5.

Automatic logout:

The display switches back to the screen saver after the predefined delay time (**factory setting 10 minutes**) has elapsed. After a further minute has elapsed, the screen saver is dimmed and an automatic logout to user level 0 is performed.

The login process must be repeated before any settings can be made.

6.2 Operating modes menu

Operating modes

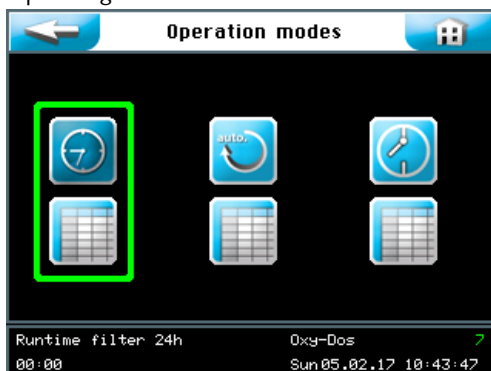

General information about the control sequence

Explanation of the symbols



Return button

The Return button leads back to the previous view.



Home button

The Home button leads to the main menu.

After tension connection (normally the device must be connected at the main switch)

Display logo 20 seconds

Connection delay for the program sequence 30 minutes

Sequence of the dosing cycle

- Rinsing pump on 10 minutes. When there is no error, the dosing of granules follows.
 - Dosing of the granulate volume as adjusted and/or as corrected by means of the temperature factor. Setting in 10 grams steps from 50 to 500 grams.
 - Rinsing 10 minutes
 - End dosing of an algaecide – dosing volume adjusted in ml at the touch - control and dosing pump integrated. Algaecide program activatable on/off
 - Refill appr. 10 minutes to clean the rinsing device - only when algaecide program is activated.
- The adjusted dosing powers can be changed always after entering the password.

6.2.1 Operating mode clock timer, settings at 24 h cycling time

Clock timer

The filter system works 24 hours and the dosing device is always supplied with tension.

Setting a start time, e.g. start at 8.00 h.

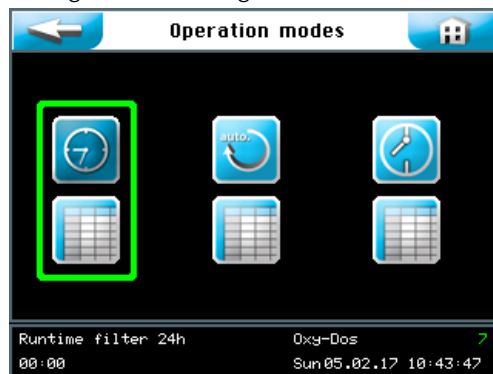

 Operating mode - select clock timer

 Then switch to the adjustments for the clock timer
Entering settings for the clock timer

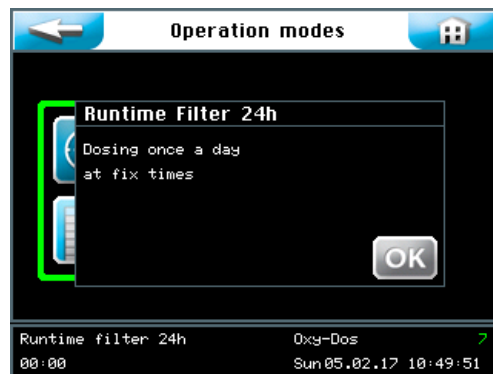

Indication that there is dosing 1x a day.
Confirm with **OK**

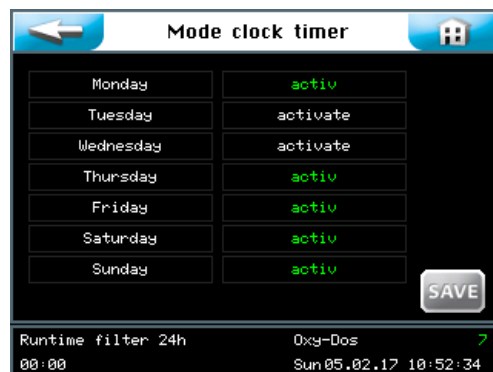

Selection of the days on which dosing must be done.

You can **activate** or deactivate the desired day of the week by pressing the corresponding button in the right column.

Save with **SAVE**

Touch the left column of the relevant day of the week to enter the starting time for this day.

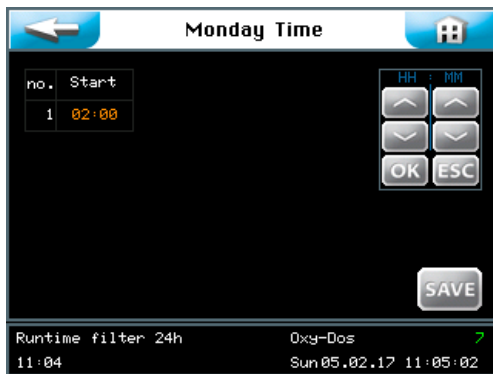

Adjustment of the start time for the dosing program
Confirm with **OK**

Save with **SAVE**

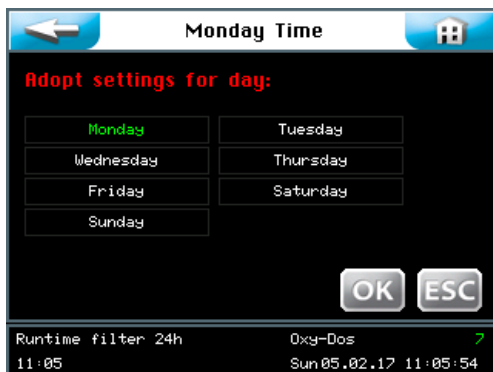

Now you activate the start time for the previously selected days.

Notice:

You can also introduce different start times for the different days.

Confirm with **OK**



Confirming values; with **OK** or terminate with **ESC**.

With the button  you return to the week list.
(Repeated request to save)

Complete with **SAVE**.

In this way the days, on which dosing is to be done, and the start times are fixed.

6.2.2 Operation mode continuous, adjustments in case of a limited filter run time

The filter system is only working for a limited time during the day. The dosing device is constantly supplied with tension, when the filter system is working.

Configuration of a time window during which the filter system is running securely, for example start between 8.00 and 10.00 h.

- Selection of the day of the days on which dosing is to be done.
- Determine a time window in which the filter system is running securely
- When the filter system starts in this time window or is already active, the dosing cycle starts 30 minutes after the filter start, or 30 minutes after the adjusted start time

There is maximum 1x dosing a day.

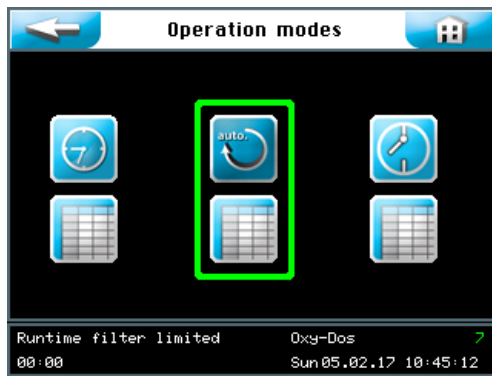

Start / select operating mode continuous



Enter the settings for the continuous mode

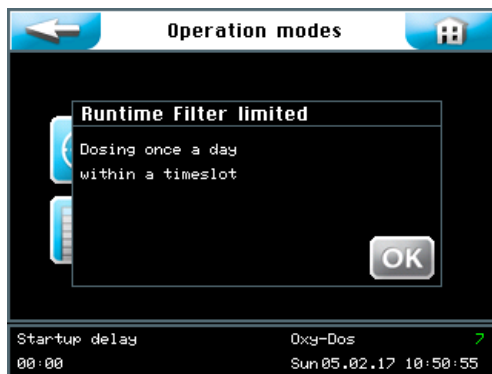

Notice: each day there is 1 dosing within a certain time.

Confirm the information text with **OK**.

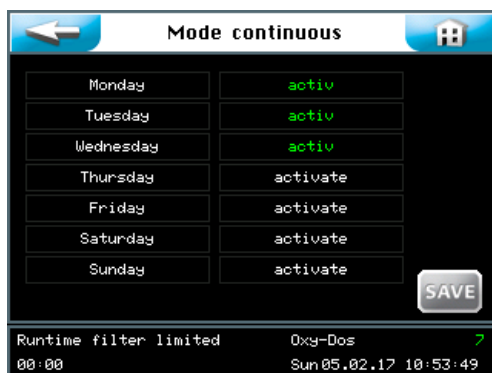

Selection of the days on which dosing must be done.

You can activate or deactivate the desired days of the week by pressing the corresponding button in the right column.

Save with **SAVE**

Touch the left column of the relevant day of the week to enter the starting time for this day.

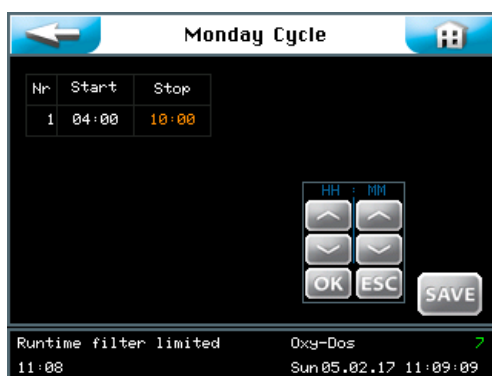

Setting the time window for the dosing program

Confirm with **OK**

Save with **SAVE**

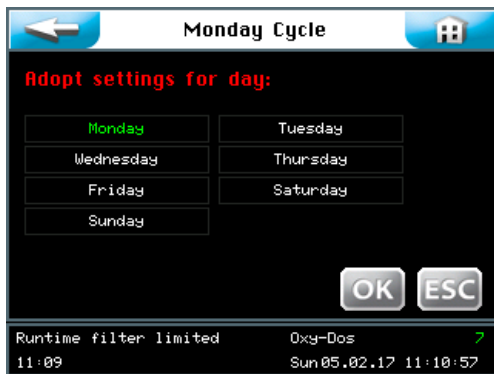

Now you activate the adjusted time window for the previously selected days.

Notice:

For the different days you can also introduce different time windows.

Confirm with **OK**

With the button  you return to the week list. (Repeated request to save)



Confirming values; with **OK** or terminate with **ESC**.

Complete with **SAVE**

In this way the days, on which dosing needs to be done and the time window are fixed.

6.2.3 Operating mode External control

The dosing is controlled by an external measurement and regulation device. When an adjusted value is not reached, the Oxy-Dos gets a control contact. The dosing is started when the control contact falls in the adjustable time window, for example time window between 8.00 and 10.00 h.

- Select all days in the day chart
- Determine a time window in which the filter system is running securely
- When the filter system is active in this time window, the dosing cycle will start 30 minutes later.

Notice:

When the dosing is activated outside the adjusted time window, the dosing takes place the next day in the time window - then the adjusted value will not be reached anyhow and the control contact will be active.

Dosing is done 1x a day.

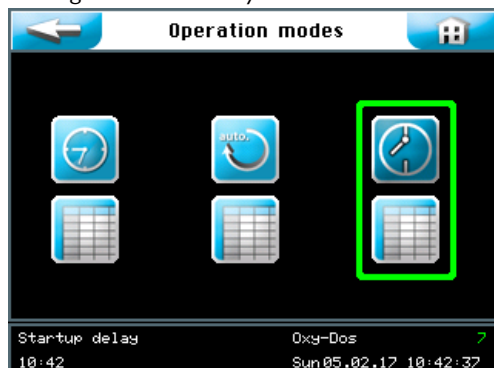

 Start / select operation mode External control

 Enter the settings for the continuous mode

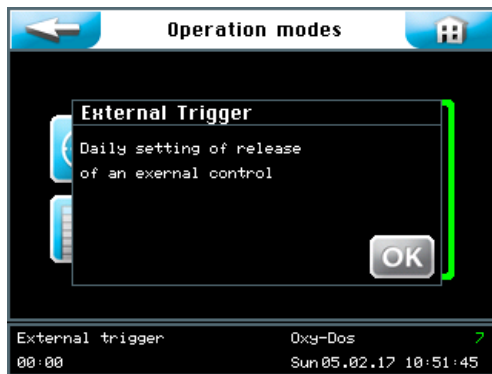

Notice, for the external control of the dosing.

Confirm the information text with **OK**.



Selection of all days.

Save with **SAVE**

Touch the left column of the relevant day of the week to enter the time window for this day.



Setting the time window for the dosing program

Confirm with **OK**

Save with **SAVE**

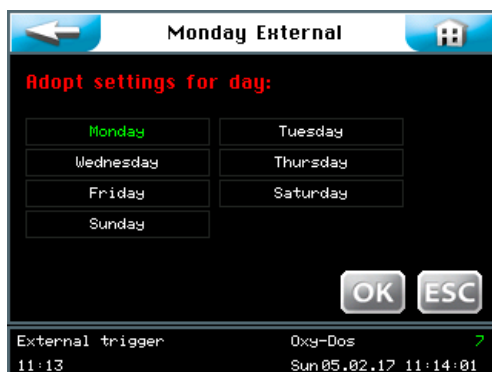

Now mark all days green again.

Confirm with **OK**

With the button  you return to the week list. (Repeated request to save)

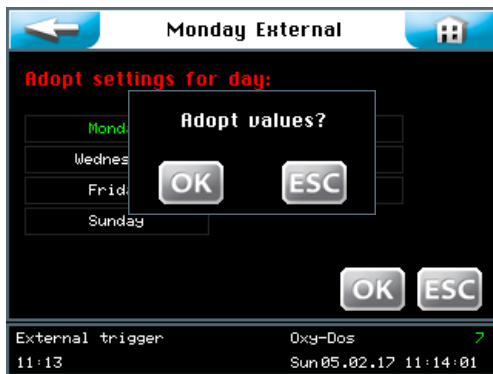

Confirming values with **OK** or terminate with **ESC**.

Complete with **SAVE**

In this way all days, on which dosing is possible, and the time window are fixed.

6.3 Settings menu

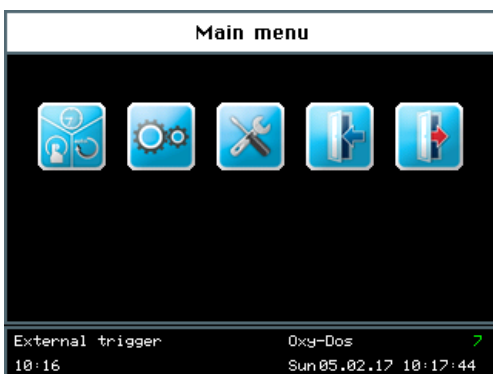

Select "Adjustments" in the main menu

Here the adjustments for the system configurations and the dosing configurations are carried out.

6.3.1 Menu Adjust dosing power for oxygen and algacide

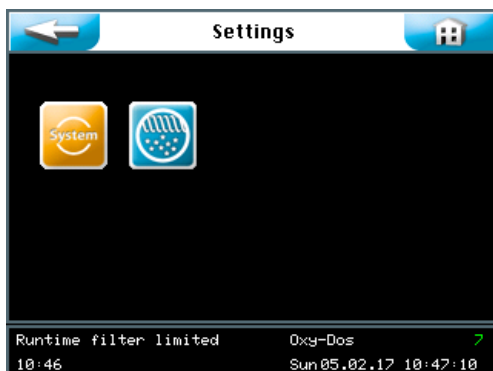

Select "Dosing" in the adjustment menu.



Select the desired time → the number is displays in orange → Adjustment of the desired dosing power; the adjustment is done in steps of 50 and 10 → Reset with **OK**

Activate or deactivate the algacide dosing

Save with **SAVE**

Analysis of the dosing volumes:

Oxygen: approximately 15-30 g/m³ pool contents/week, oxygen volume in the water 10-30 mg/l.

Algacide: approximately 10 ml/ m³ pool volume/week

The adjustments are done in steps of 50 and 10.

6.3.2 System menu



Select "System" in the adjustment menu



You may choose between 7 operating modes:

1. Language
2. Date + time
3. Display and backlight
4. Reset
5. User settings / password allocation
6. WDT menu 2
7. Log files



The  leads to the previous view.

6.3.2.1 Language

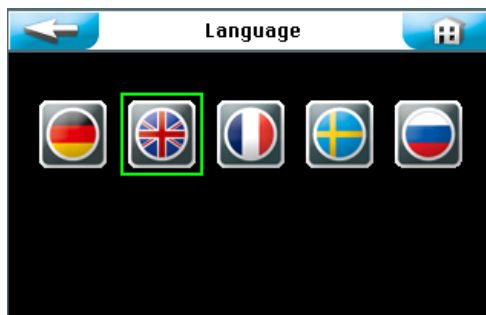

Select the preferred language.



The  leads to the previous view.

6.3.2.2 Date + time

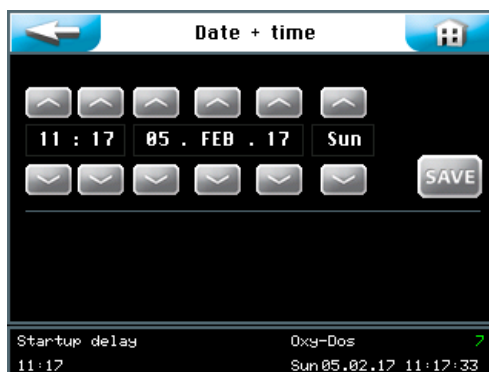

With the arrow buttons you adjust the desired date and time. Save and complete the entry with **SAVE**.

As soon as the **SAVE** button is pressed, the time starts running!



The  leads to the previous view.



HINT !

The adaptation of the time to summer and winter time must be manually performed!

6.3.2.3 Display



Here the adjustments for the display and the buttons are carried out.

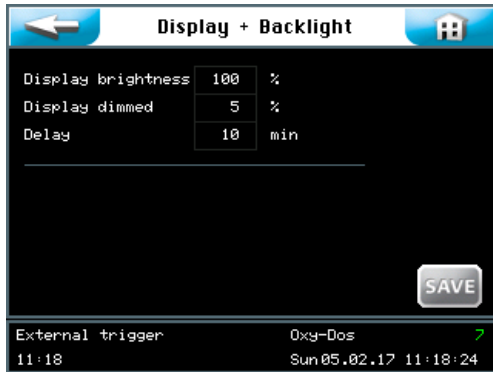

The display switches to full **Display brightness** when the touch display is touched. The display switches back to the screen saver after the predefined **Delay** has elapsed. One minute later, the screen saver is dimmed to the **Display dimmed** value and an automatic logout to user level 0 is performed.

Then the password must be entered again for other adjustments.

6.3.2.4 Reset



All adjusted values are reset to the “factory settings”.

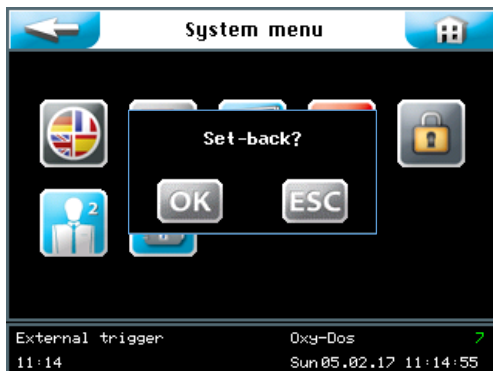

Confirm the selection with **OK** so that the software can be reset to factory settings. The current settings are retained when you terminate the command with **ESC**.

6.3.2.5 User settings / password allocation



Here the password for the user level 1 can be changed.



Select which password is to be changed.

Guest	User level 0	without password
Final customer	User level 1	password 4 characters
Technician 1	User level 2	not active
Technician 2	User level 3	not active
Net admin	User level 4	not active



Enter the respective password and confirm the entry with **OK**.

The password was successfully changed when the display returns to the "System Menu" after the last entry. The user level selected will be shown in green in the information line.



HINT!

Please note the changed password.

6.3.2.6 WDT menu 2



In this menu the device information is shown: hardware and software version, delivery date and serial number. Indication of the number of dosing cycles since the last reset and the total, until know (mathematically) registered volume of oxygen granulate.



With the reset button the dosing volume and the number of dosing cycles is put back on "0".

6.3.2.7 Log file



The log file, including the last 255 events, is stored by the software. Errors are displayed in red.

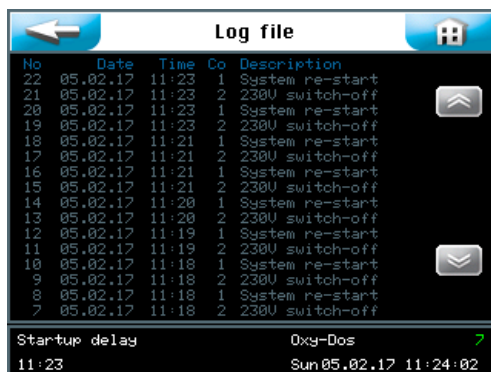

As example: "230V shutdown"

6.4 Service menu

The Service menu can be used for functional tests of actuators and the controller. They are also used for fault searches.

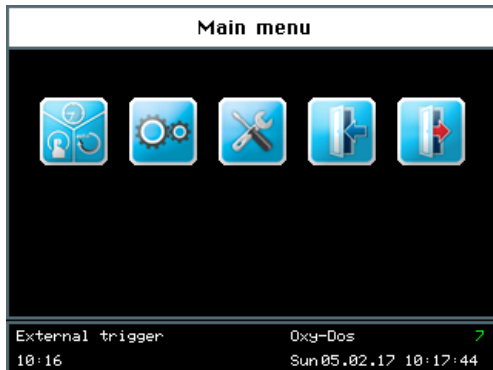

Select program “Service menu”



You can select one of 5 menus with the touch screen:

1. Inputs test menu
2. Outputs test menu
3. Test dosing menug – Quick walk through of the dosing cycle
4. Activation of a complete dosing cycle
5. Information test menu

6.4.1 Inputs test menu



Test switch inputs

With this function the switch functions of the control are tested.

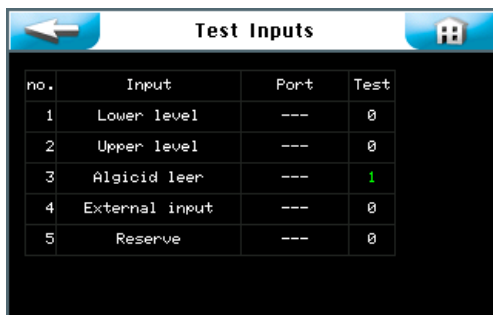

no.	Input	Port	Test
1	Lower level	---	0
2	Upper level	---	0
3	Algacid leer	---	1
4	External input	---	0
5	Reserve	---	0

Upon sliding the corresponding switch in direction of the function, “0” is changed into “1”, when the switch does not work correctly.

Terminal: Allocation of the terminal point on the PC board

6.4.2 Outputs test menu



Test Output function
With this function the electrical output functions are tested.

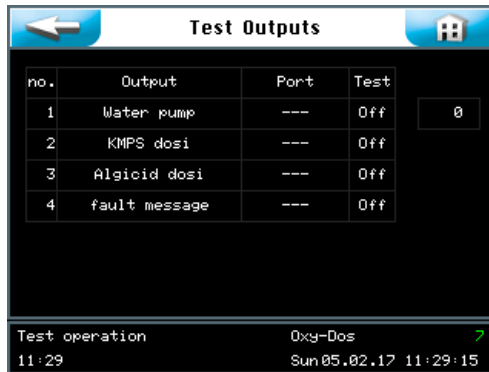

no.	Output	Port	Test
1	Water pump	---	Off
2	KMPS dosi	---	Off
3	Algicid dosi	---	Off
4	fault message	---	Off

Test operation: Oxy-Dos
11:29 Sun 05.02.17 11:29:15

The desired test run is started by tipping on the field **Off**. The word **Test** appears in a green font in the field and the timer counts from 240 seconds to 0. The selected function is active in this time.

6.4.3 Test dosing menu quick walk through



Test function for a quick walk through of the complete dosing program: each function is active for 20 seconds.

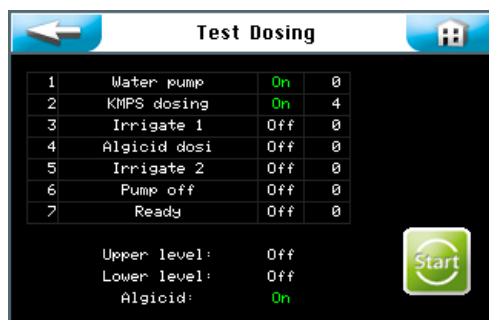

no.	Output	Port	Test
1	Water pump	0n	0
2	KMPS dosing	0n	4
3	Irrigate 1	0ff	0
4	Algicid dosi	0ff	0
5	Irrigate 2	0ff	0
6	Pump off	0ff	0
7	Ready	0ff	0

Upper level: 0ff
Lower level: 0ff
Algicid: 0n

The steps of the dosing program are activated during 20 seconds each. The operator checks the correct functioning of the actuators activated.

6.4.4 Test menu for manual dosing



Realisation of a complete dosing cycle with original sequence, for example after an error or when a reflux was forgotten.

This program can also be selected to activate the rinsing pump easily, for example during commissioning.

6.4.5 Information test menu



Here the device data are shown. These data are also important in case of questions and customer service items.



Product: Oxy-Dos
Software version: 2.0.1
Hardware version: 1.1
Delivery date
Serial no.

Werner Dosiertechnik GmbH & Co. KG
Hettlinger Str. 17
86637 Wertingen
www.werner-dosiertechnik.de

External trigger: Oxy-Dos
11:33 Sun 05.02.17 11:33:37

These data are introduced in the plant.

6.5 Logout

Here you can logout actively.

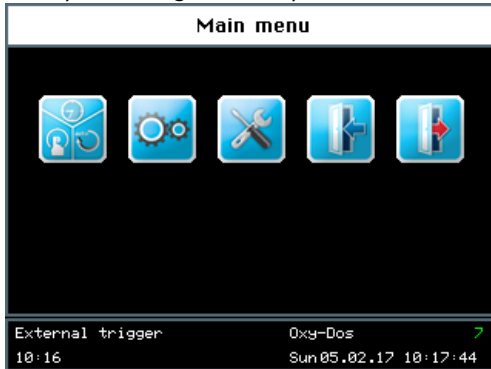

Automatic logout:

The display switches back to the screen saver after the pre-defined time delay has elapsed. After a further minute has elapsed, the screen saver is dimmed and an automatic logout to user level 0 is performed.

The login process must be repeated before any settings can be made.

6.6 Top up consumables

- Refill algaecide

For the replacement of the algaecide can, see *Section Commissioning, connect algaecide can.*

The specifications in the safety data sheets for the respective chemicals must be adhered to!

- Refill oxygen granule

For exchanging the oxygen granule, see *Section 5.6, Filling the filling hopper*

7 Maintenance, service

7.1 Device maintenance

It is recommended to task a specialist company with maintenance.



DANGER DUE TO HIGH VOLTAGE !

The device must be switched off and secured against re-operation before any electrical work is carried out! (Pull of the plug!)

7.2 Exchanging the dosing unit

The dosing unit screwed beneath on the dosing hopper can only be changed as one unit. Therefore you pull the plug out of the electrical connection, you take the dosing hopper out of the housing and you unscrew the dosing unit from the hopper.

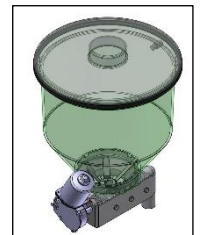

7.3 Change the floater regulating valve for the supply to the rinsing tray

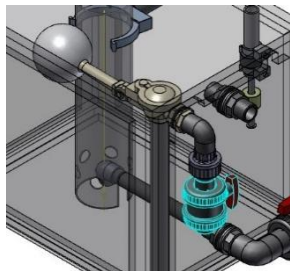

The floater valve can only be changed as one unit.

7.4 Change the dosing hose of the algacide pump

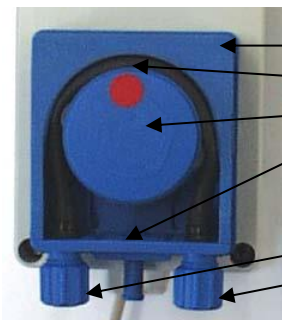

Pump housing
Roller carrier
Lock washer
Hose support with connections
Suction side
Pressure side

Attention

The hose may not be twisted after insertion.

Take note of the markers!

7.5 Errors with error message in the display



Hint !

Switches or sensors may also be defect.

Fault indication 1



“Upper level switch does **not** switch”

The water is **not** sucked out of the rinsing tray

When after 10 minutes after the start the rinsing water pump of the upper level switches is **not** active yet, follows:

- No dosing, the pump goes on running,
- potential free error message active.
- but also: the switch may be defect

At the “Service” menu → “Outputs” → Activate the pump → The pump should run:

- Check the water supply to the pump – are all cocks open?
- Ball valve in the exit conduct closed?
- Activate the floater valve of the floater: The floater of the floater valve is clamping?.
- Floater valve does not react? Not enough? Change floater valve.
- Reflux valve on the rinsing pump is clamping?

If the pump does not run:

- Check the tension at the pump: when there is tension → Pump defective - condensator
- Check the tension on the connection terminals of the control plate:
 - There is tension → Cable defective
 - There is no tension → Control relay, control board defective

Fault indication 2



“Lower level switch does **not** switch”

More water is sucked from the rinsing tray than there is reflux water.

When at the start or during the dosing the lower level switch is active, then:

- Rinsing water pump off, → Dosing off,
- potential free error message active.
- but also: the switch may be defective

At the “Service” menu → “Outputs” → Activate the pump → Pump is running:

- Check the water supply – are all cocks open?
- Activate the floater valve of the floater: The floater of the floater valve is clamping?.
- Floater valve does not react? Not enough? Replace floater valve.
- Check pressure: is the pressure less than 0.5 bar? The appropriate perforated plate has been placed? See Assembly/commissioning, Section 4/5.

Fault indication 3

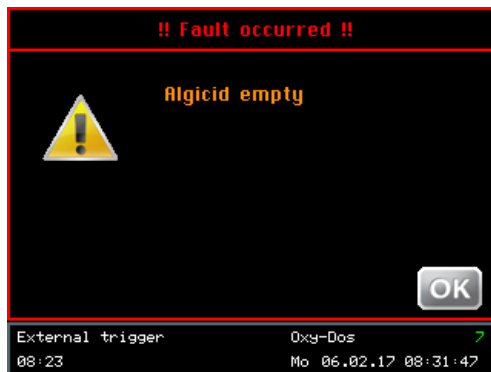

“Algicide empty“

The algicide can is empty or the empty switch is defective.

7.6 Errors that are not being shown

No oxygen in the water – otherwise no fault indication in the display.

- The dosing power has been adjusted too low – Increase the dosing power.
- The dosing hopper is empty.

If not empty: At the “Service” menu → “Outputs“ → Activate the dosing motor

The dosing motor does not rotate:

- Check the fuse F1 on the plate NT-35-Expansion for the dosing engine = measure!! Install new slow blow fuse 315 mA.
- The fuse triggers again.
- Extract the dosing device from the housing, empty the dosing hopper
- Clean the downpipe if clogged. When the dosing plate is clogged/locked, clean it.
- Disassemble the dosing engine with the dosing screw, see *Section 7.2*
- Clean the downpipe if clogged. When the dosing plate is clogged/locked, clean it.
- Install new fuse, activate test run.
- When the endless screw is now turning, re-assemble the dosing device.
- If the endless screw is not turning now, measure the tension on the connection clamps of the dosing engine (see terminal scheme). In case of a correct tension (20-22 VDC – when locked, the tension falls!) and the motor is not turning, then the motor is defect and must be replaced.
- Another possibility could be an interruption or a bad contact of the tension supply of the engine: When the complete tension is available, an interruption is the cause, in case of a smaller tension, a locking is the cause

Overflow from the rinsing tray upon disconnecting the Oxy-Dos.

- Floater valve defect → Replace
- Reflux valve on the pump defect: Disassemble, check the leakproof device and the joint, replace the joint.
- A smaller overflow is irrelevant for the working of the device.

8 Shutting down - Storage - Disposal

8.1 General

Disposal of old part and operating materials

De-installed, contaminated parts must first be thoroughly cleaned and then disposed of according to the regulations valid at the place of operation or recycled. The instructions on the packaging of chemicals must be complied with. In case of doubt, you can obtain all information from your supplier or from the place responsible for the disposal where you live.

Storage

Store the device at a dry place.

8.2 Shutting down

- Disassemble the dosing hose of the algacide pump from the housing.
- Extract the dosing hopper from the housing and empty, clean thoroughly - do not use any water!! All water-conducting parts are to be drained when there is a risk of frost, in particular the pump may not be forgotten
- Switch off the Oxy-Dos 10 at the main switch.

The maintenance works are described comprehensively in the appendix. We recommend that these works are done by a specialised company.



ATTENTION !

The instructions in the "Commissioning" chapter must be adhered to and the steps in the commissioning protocol must be performed when re-operating the device.

9 **Documents**

9.1 Declaration of conformity

Handing-over upon request

9.2 Terminal plans - power board / net board

Terminal schemes are also in the control housing.

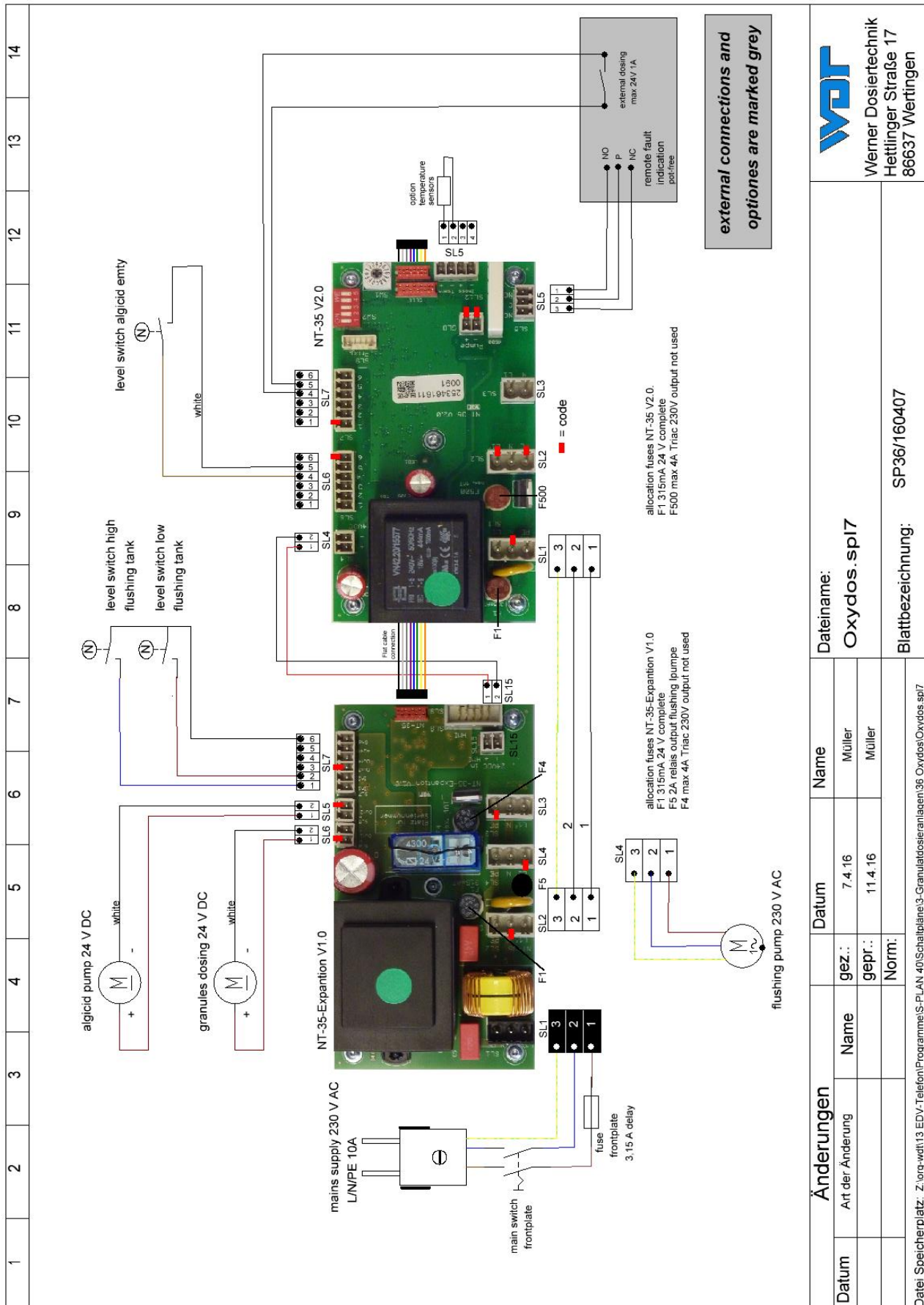

9.3 Commissioning report

Commissioning protocol for Oxy-Dos

Also see the operating instruction in Section 5. Initial operation

Object:..... Date.....
Model:..... Year of construction:..... S/N.....
Commissioning performed by..... Signature.....
Countersigned by operating manager:.....

1. Rinsing device (with the switches observe an activation delay of 6 seconds!)

- 1.1 **Check level switch:** → Service → Inputs: Switch body high 0 → 1 []
- 1.2 **Check level switch:** → Service → Inputs: Switch body low 0 → 1 []
- 1.3 **Adjust the water level –** []
- 1.4 **Floater valve Check function –** Flow is reacting smoothly []
- 1.5 **Bleed the pump** []

2. Dosing system Oxy-Dos

- 2.1 **Dosing motor function:** → Service → Outputs → Dos-Test → Dosing engine is running []
- 2.2 **Instruction in the refilling of oxygen granulate § 4.7** []

3. Dosing system algacide

- 3.1 **Empty switch function** → Service → Inputs: Switch body high - 0 → 1 []
- 3.2 **Dosing pump function:** → Service → Outputs → Dos-Test → Algacide sucks in []

4. Control - after opening the controller

- 4.1 **All connecting plugs: fixed engaged** []
- 4.2 **Test programs:** []
- 4.3 **Test “Inputs“** []
- 4.4 **Test “Outputs“** []

5. Other work

- 5.1 **Thoroughly clean Oxy-Dos** []
- 5.2 **Clean surroundings of Oxy-Dos** []
- 5.3 **Operation manual discussed and handed over** []

Only completed and signed commissioning report without any guarantee!

9.4 Maintenance protocol

Object:..... Date:.....

Oxy-Dos model:..... Year of construction:..... S/N.....

Maintenance performed by:.....

Countersigned by owner:.....

<u>This must be done:</u>		↓	<u>..... this was also necessary.....</u>		↓
<u>1. Rinsing system:</u>		↓			↓
1.1	<u>Check level switch:</u> OK	[]	<u>replace</u>	[]	
1.5	<u>Check the floater valve function</u> OK	[]	<u>replace</u>	[]	
1.6	<u>Adjust floater valve water level</u> OK	[]			
<u>2. Dosing system oxygen-granulate</u>					
2.3	<u>Check dosing screw, clean with brush</u> OK	[]	<u>replace</u>	[]	
2.4	<u>Check power of the dosing engine – Must be 5 kg/h +/-0,2 kg</u> OK	[]	<u>replace</u>	[]	
<u>3. Dosing system algaeicide</u>					
3.1	<u>Empty switch function:</u> OK	[]	<u>replace</u>	[]	
3.2	<u>Dosing pump function – performance</u> OK	[]	<u>replace</u>	[]	
3.3	<u>Replace dosing hose</u>	[]	<u>annual replace</u>	[]	
<u>4. Other work</u>					
4.1	<u>Thoroughly clean Oxy-Dos</u>	[]			
4.2	<u>Clean surroundings of the Oxy-Dos</u>	[]			

9.5 Spare parts list, wearing parts list



Hint !

Do you need spare parts, wearing parts or consumables? Your service partner or specialist dealer will gladly provide those on request.

Spare parts list Oxy-Dos 10

<u>Device component</u>	<u>Description</u>	<u>Item no.</u>
O2 dosing unit	Dosing motor	25985
	Dosing screw with housing	25986
	Dosing unit complete	25873
Algaecide dosing unit	Dosing motor	25975
	Hose set 4.8 x 2.4	20311
	Roller carrier	13705
	Suction lance N 30l GR10 comp.	12523
Water assembly	Floater valve	25796
	Ball valve d20	10119
	Ball valve d25	10120
	Reflux valve d20	15386
	Level switch 2 NIG	25987
	Set seals Oxy-Dos	25988
Control	Front plate complete with touch display	25990
	Main switch	11338
	Fuse holder	13960
	Set fuses Oxy-Dos	25989
	Control board OxyDos premounted, includes: control board NT 35 and NT 35-Expansion	27145

10 Appendices

Own notes
